Installation and Service Guide

Publication number E3491-97001
Second edition, August 1995

For Safety information, Warranties, and Regulatory information, see the
pages behind the index.

© Copyright Hewlett-Packard Company 1994, 1995
All Rights Reserved

HP E3491A Pentium Probe

HP E3491A Pentium Probe—At a Glance

The HP E3491A Pentium Probe provides a low-cost way to debug embedded software for Intel Pentium™ microprocessors. It can also be used with the HP E2457A Preprocessor Interface for microprocessor code disassembly.

The target connection

The HP E3491A Pentium Probe connects to your target microprocessor via a special connector on the target system, or through the HP E2457A Preprocessor Interface.

The HP 16505A connection

The HP E3491A Pentium Probe connects to the HP 16505A Prototype Analyzer via an Ethernet LAN for remote operation, or directly for point-to-point operation. The logic analyzer connects to the HP 16505A through a SCSI connector.

The configuration switches

Use the switches to configure communication to the HP 16505A. There is a guide to these switches on the bottom of the HP E3491A Pentium Probe.

The status LEDs

LEDs show the status of the power supply, the target system, and the connection to the HP 16505A.

Additional equipment required

The HP E3491A Pentium Probe requires the HP 16505A Prototype Analyzer.

Compatibility with other products

The HP E3491A Pentium Probe and HP 16505A Prototype Analyzer can also be used with the HP E2457A Preprocessor Interface.

Figure 1

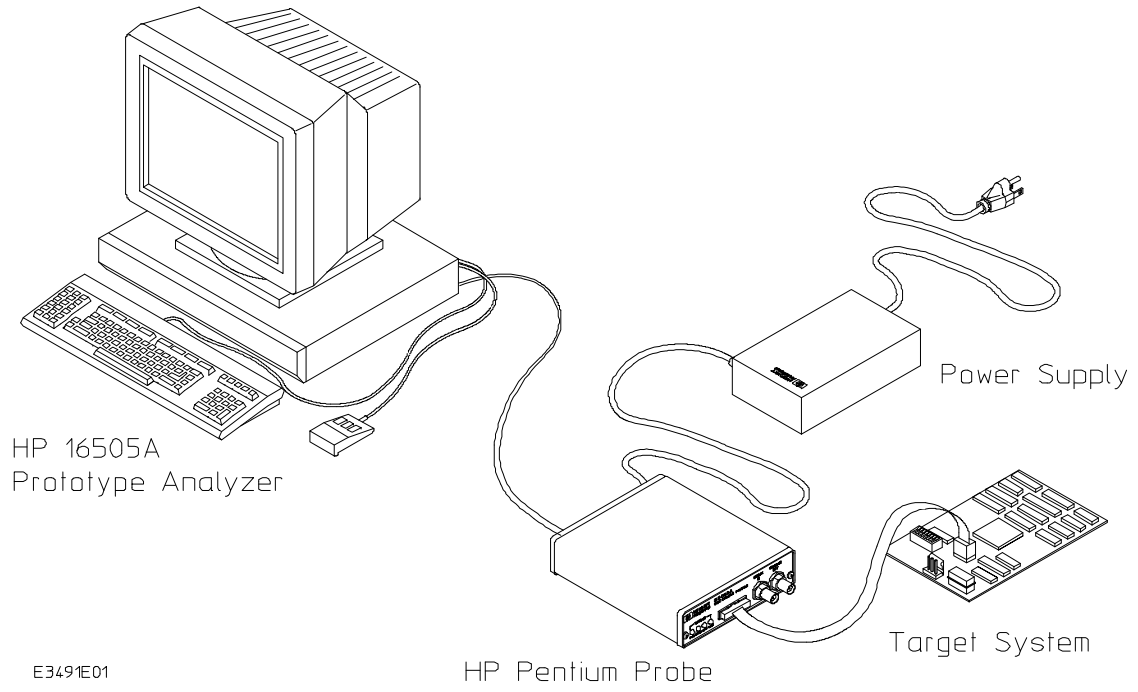

**HP E3491A
Pentium Probe**

Part 1 Installation

1 Connecting to the HP 16505A Prototype Analyzer

Equipment supplied 4

Installing the software in the HP 16505A Prototype Analyzer 5

Connecting the HP E3491A Pentium Probe to a Power Source 6

To choose a power cord 6

To connect the power cord and turn on the HP E3491A Pentium Probe 7

Connecting the Probe to the Prototype Analyzer 8

Connecting for a point-to-point configuration 9

Connecting to a LAN 10

To set the 10BASE-T configuration switches 12

Setting Up LAN Communication 13

To verify LAN communications 14

Setting Up a Serial Connection 15

To set the serial configuration switches 16

To connect a serial cable 16

To verify serial communications 17

To configure LAN parameters using the built-in terminal interface 18

2 Connecting to the Target System

Connectors provided 22

To test the HP E3491A Pentium Probe 23

To connect to a target system via the Intel defined debug port 23

To connect to a target system via the HP E2457A Pentium Preprocessor 24

Part 2 Reference

3 Designing a Target System

Designing a target system for use with the HP E2457A Preprocessor Interface 30

Designing a target system for use with the Intel-defined debug port 31

4 Specifications and Characteristics

Processor Compatibility 34

Electrical Specifications 34

Environmental Specifications 36

Pinout for 30-pin HP E3491-66503 Adapter Board 37

5 Solving Problems

Status Lights 42

Problems with the LAN Interface 43

If you cannot verify LAN communication 43

If you have LAN connection problems 44

If the "POL" LED is lit 44

If it takes a long time to connect to the network 45

Problems with the Serial Interface 46

If you cannot verify RS-232 communication 46

If you have RS-232 connection problems with the MS Windows Terminal program 46

Problems with the HP E3491A Pentium Probe Itself 48

To run the power up self test 48

To execute the built-in performance verification test 50

Returning the HP E3491A Pentium Probe to Hewlett-Packard for Service	56
To return the HP E3491A Pentium Probe to Hewlett-Packard	56
To obtain replacement cables	57

Figures

HP E3491A Pentium Probe	iii
Powering up the Pentium Probe	7
Point-to-point Connection	9
LAN Connection	11
Switch Positions for LAN (left) and 10BASE-T LAN (right) Configurations, S6 Open for Initialization	11
Connecting through the HP E2457A Preprocessor Interface	25
Status Lights	41

Part 1

Installation

Connecting to the HP 16505A Prototype Analyzer

Connecting to the HP 16505A Prototype Analyzer

To use the HP E3491A Pentium Probe you need to:

- Install the HP E3491A software (Run Control Tool) in the HP 16505A Prototype Analyzer
- Connect the HP E3491A Pentium Probe to a power source
- Connect the HP E3491A Pentium Probe to the HP 16505A via a LAN or direct connection
- Connect the HP E3491A Pentium Probe to the target system (described in the next chapter)

Equipment supplied

The following equipment is supplied with the HP E3491A Pentium Probe:

- A 20-conductor cable assembly (HP part number E3491-61601)
- A 30-conductor cable assembly (HP part number E3491-61602)
- An adapter board (HP part number E3491-66503)
- A 2-conductor cable assembly with SMT Grabbers (HP part number 64762-61602)
- A self-test connector (HP part number E3490-61604)
- A 7 ft. 10Base-T point-to-point network cable (HP part number 5061-7342)

Installing the software in the HP 16505A Prototype Analyzer

To install the HP E3491A software (Run Control Tool) in the HP 16505A Prototype Analyzer:

- Power up the prototype analyzer.
- Insert the HP E3491A floppy disk in the floppy disk drive.
- In the Session Manager menu, select Update. The prototype analyzer will read the directory of the floppy disk.
- When the menu changes to show the file group "E3491A", select Update/Install. The menu will query "Install the file group E3491A?" Select OK. When the installation is complete, the menu will display "Filegroup E3491A successfully installed." Select OK.
- Close the HP 16505A Update/Install window.
- To verify installation, start a session in the HP 16505A. Look for the μ p Control Tool in the Toolbar. If the μ p Control Tool is in the Toolbar, the installation is complete.

Connecting the HP E3491A Pentium Probe to a Power Source

The HP E3491A Pentium Probe does not have an On/Off switch. To turn the HP E3491A Pentium Probe on or off, plug or unplug it from the power supply.

To choose a power cord

The HP E3491A Pentium Probe is shipped from the factory with a power supply and cord appropriate for your country. If the cord you received is not appropriate for your electrical power outlet type, contact your Hewlett-Packard sales and service office.

Warning

Use only the supplied HP power supply and cord.
Failure to use the proper power supply could result in electric shock.

Caution

Use only the supplied HP power supply and cord.
Failure to use the proper power supply could result in equipment damage.

To connect the power cord and turn on the HP E3491A Pentium Probe

1 Connect the power cord to the power supply and to a socket outlet.

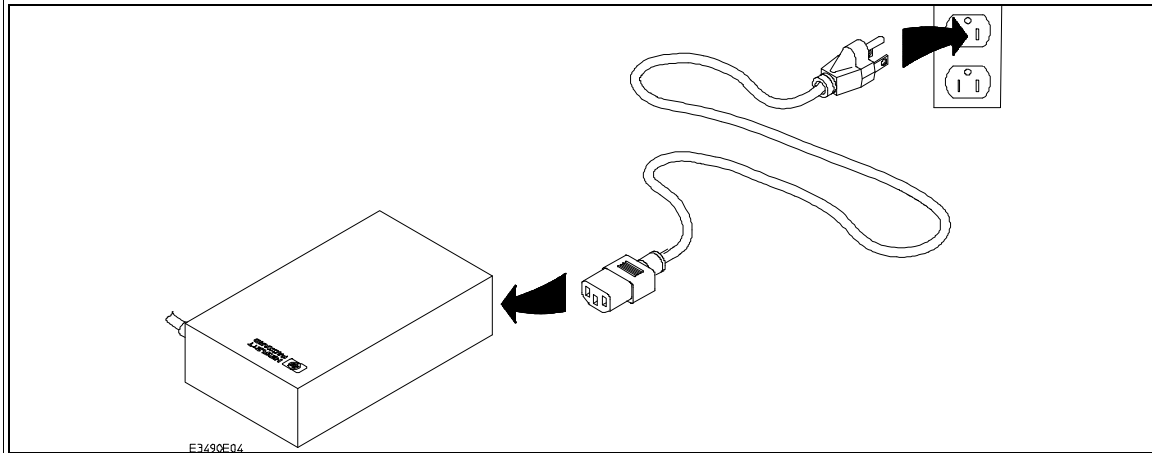

2 Connect the 5V power cord to the back of the HP Pentium Probe.

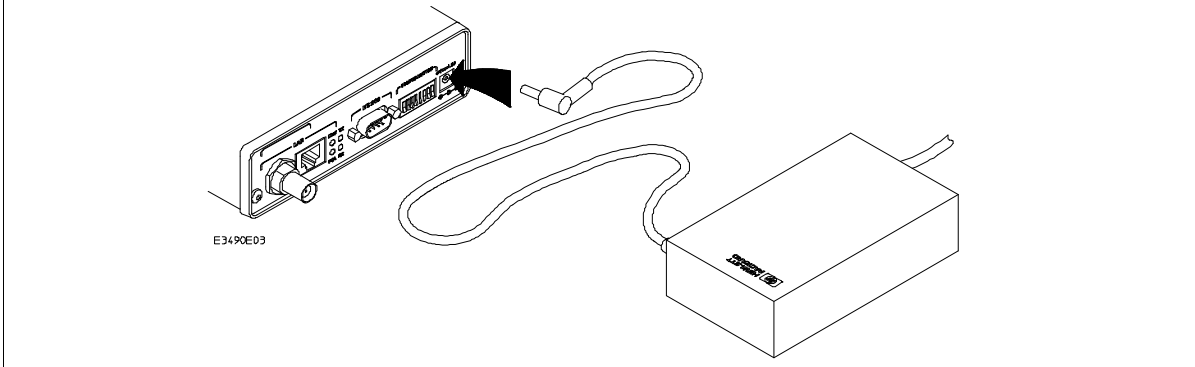

The power light on the target side of the HP Pentium Probe will be illuminated. The HP Pentium Probe does not have an On/Off switch.

Figure 2. Powering up the Pentium Probe

Connecting the Probe to the Prototype Analyzer

The Pentium probe can be connected directly to the prototype analyzer for a point-to-point connection, or it can be connected via a LAN. The LAN connection allows remote operation; it also allows a probe to be shared by more than one prototype analyzer.

The following sections describe the connections for point-to-point and LAN configurations.

Connecting for a point-to-point configuration

The point-to-point connection is technically a LAN connection, with only two nodes.

- Use the supplied 10Base-T cable (HP part number 5061-7342) to connect the Pentium probe directly to the prototype analyzer (see figure 3).
- The configuration switches must be set for a LAN configuration. Switch 1 must be set to OPEN, indicating that a LAN connection is being made. Since this is a 10BASE-T connection, switch 5 must also be set to OPEN (see figure 5).
- Use the procedure in "Setting Up LAN Communication" to set the Ethernet address, IP address, and gateway address.

Figure 3

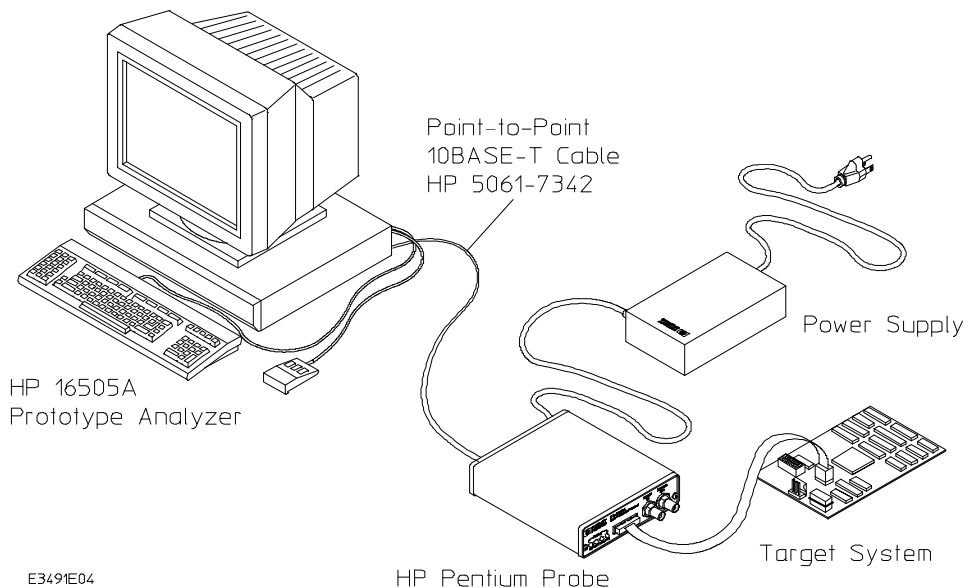

Point-to-point Connection

Connecting to a LAN

The HP E3491A Pentium Probe has two LAN connectors (see figure 4):

- A BNC connector that can be directly connected to an IEEE 802.3 Type 10BASE2 cable (ThinLAN). When using this connector, the HP E3491A Pentium Probe provides the functional equivalent of a Medium Attachment Unit (MAU) for ThinLAN.
- An IEEE 802.3 Type 10BASE-T (StarLAN) connector.

Caution

Use either the 10BASE2 or the 10BASE-T connector. Do *not* use both. The HP E3491A Pentium Probe will not work with both connected at the same time.

The configuration switches must be set for a LAN configuration. Switch 1 must be set to OPEN, indicating that a LAN connection is being made. For 10BASE-T connections, switch 5 must also be set to OPEN (see figure 5). Refer to "To set the 10BASE-T configuration switches" for additional information on configuring 10BASE-T switches.

Use the procedure in "Setting Up LAN Communication" to set the Ethernet address, IP address, and gateway address.

Figure 4

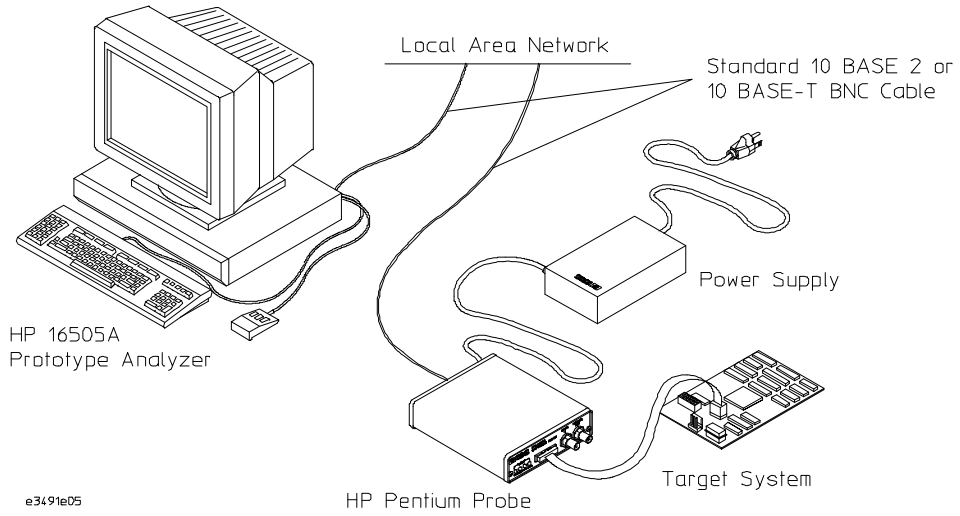

LAN Connection

Figure 5

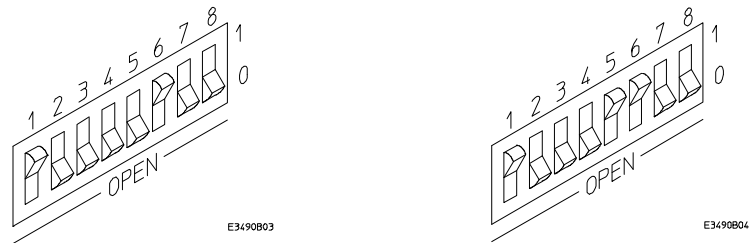

Switch Positions for LAN (left) and 10BASE-T LAN (right) Configurations, S6 Open for Initialization

To set the 10BASE-T configuration switches

Set switches S7 and S8 to CLOSED unless one of the following conditions is true:

- **If the LAN cable exceeds the standard length, set switch S7 to OPEN.**
The HP E3491A Pentium Probe has a switch-selectable, twisted-pair receiver threshold. With switch S7 set to OPEN, the twisted-pair receiver threshold is lowered by 4.5 dB. This should allow you to use cable lengths of up to about 200 meters. If you use a long cable, you should consult with your LAN cabling installer to ensure that:
 - The device at the other end of the cable has long cable capability, and
 - The cable is high-grade, low-crosstalk cable with crosstalk attenuation of greater than 27.5 dB.

When switch S7 is set to CLOSED, the LAN port operates at standard 10BASE-T levels. A maximum of 100 meters of UTP cable can be used.

- **If your network doesn't support Link Beat integrity checking or if the HP E3491A Pentium Probe is connected to a non 10BASE-T network (such as StarLAN) set this switch to LINK BEAT OFF (0 or OPEN).**

In normal mode (switch S8 set to CLOSED), a link integrity pulse is transmitted every 15 milliseconds in the absence of transmitted data. It expects to receive a similar pulse from the remote MAU. This is the standard link integrity test for 10BASE-T networks. If your network doesn't support the Link Beat integrity checking or if the Pentium Probe is used on a non 10BASE-T network (such as StarLAN) set this switch to LINK BEAT OFF (OPEN).

Note

Setting switch S8 to OPEN when Link Beat integrity checking is required by your network will cause the remote MAU to disable communications.

Setting Up LAN Communication

To initialize the Pentium probe, you must assign an IP address (Internet address) an Ethernet address, and a gateway address. The IP address and other network parameters are stored in nonvolatile memory within the HP E3491A Pentium Probe. These addresses must be initialized for either point-to-point or LAN connections.

The Pentium probe must be on the same subnet as the HP 16505A Prototype Analyzer. The HP E3491A Pentium Probe automatically sets the subnet mask based on the subnet mask used by other devices on the network.

To initialize the LAN parameters:

- Set the configuration switch S6 on the Pentium probe to OPEN. Cycle power to reconfigure the probe. Switch 6 causes the probe to continuously broadcast a search message over the network.
- Use the Init/Modify LAN Address menu in the HP 16505A Prototype Analyzer Run Control Tool interface to set the LAN parameters. Use the Pentium probe Ethernet address that is written on the bottom of the probe.

For point-to-point connections, use an IP address that is one greater than or one less than the HP 16505A IP address (for example, the prototype analyzer default address is 192.0.2.231, so use 192.0.2.230 or 192.0.2.232).

For LAN connections, obtain an IP address from your local network administrator or system administrator.

The gateway address is an IP address and is entered in integer dot notation. For point-to-point connections, just leave this field blank. If connections are to be made to workstations on other networks or subnets, this address must be set to the address of the gateway machine. Obtain that address from your local network administrator or system administrator.

- Enter the Ethernet address, IP address, and the gateway address in the appropriate fields, then select Set Addresses.

- Set the configuration switch S6 back to 1, then power down the probe. When the probe is powered down and then powered up, it will be configured for the new LAN parameters.

To verify LAN communications

Verify your HP E3491A Pentium Probe is now active and on the network by starting a user session on the prototype analyzer.

- 1** Drag the uP Control Tool from the toolbox to the workspace.
- 2** Move the mouse cursor over the uP Control Tool in the workspace, press and hold the right mouse button, move the cursor over Start Sys Admin Session..., and let up on the right mouse button.
- 3** Select the Verify Host Name Address menu to verify that the address is what you set. If the address is the same, then the parameters have been set.
- 4** Click the Start User Session. If no error message appears, then communication is established.

If You Have Problems

If you encounter problems, refer to the "Problems" chapter (page 39).

Setting Up a Serial Connection

If you are having difficulty establishing LAN connections and need to perform the LAN performance verification tests, you will need a serial connection.

To set up a serial connection, you will need to:

- Set the serial configuration switches
- Connect the HP E3491A Pentium Probe to the RS-232 interface
- Connect a serial cable between the host computer and the HP E3491A Pentium Probe
- Verify communications

Serial connections on a workstation

If you are using a UNIX workstation as the host computer, you need to use a serial device file. If a serial device file does not already exist on your host, you need to create one. Once it exists, you need to ensure that it has the appropriate permissions so that you can access it. See the system documentation for your workstation for help with setting up a serial device.

Serial connections on a PC

Serial connections are supported on PCs. You must use hardware handshaking if you will use the serial connection for anything other than setting LAN parameters.

If you are using a PC as the host computer, you do not need to set up any special files.

To set the serial configuration switches

- 1 Set switch S1 to CLOSED (RS-232).
- 2 Set switches S2-S4 to CLOSED.
- 3 Set switch S5 to CLOSED (HW HANDSHAKE ON) if your serial interface uses the DSR:CTS/RTS lines for flow control. Set S5 to OPEN (HW HANDSHAKE OFF) if your serial interface uses software flow control (XON/XOFF).

If your serial interface supports hardware handshaking, you should use it (set switch S5 to CLOSED). Hardware handshaking will make the serial connection much more reliable.

- 4 Set switches S6-S8 for the baud rate you will use. These switch settings are listed on the bottom of the HP E3491A Pentium Probe.

The higher baud rates may not work reliably with all hosts and user interfaces. Make sure the baud rate you choose is supported by your host and user interface.

Example

To use a baud rate of 9600 baud, set the switches as follows:

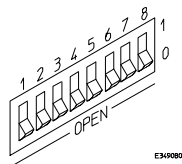

To connect a serial cable

CAUTION

Use a grounded, shielded cable. If the cable is not shielded, or if the cable is not grounded at the serial controller, the HP E3491A Pentium Probe may be damaged by electrostatic discharge.

Connect an RS-232C modem cable from the host computer to the HP E3491A Pentium Probe. The recommended cable is HP part number C2932A. This is a 9-pin cable with one-to-one pin connections.

To verify serial communications

1 Start a terminal emulator program on the host computer.

If you are using a PC, the Terminal application in Microsoft Windows will work fine.

If you are using a UNIX workstation, you can use a terminal emulator such as cu or kermit.

2 Plug the power cord into the HP E3491A Pentium Probe.

When the HP E3491A Pentium Probe powers up, it sends a message (similar to the one that follows) to the serial port and then displays a prompt:

```
Copyright (c) Hewlett-Packard Co. 1987
All Rights Reserved.  Reproduction, adaptation, or translation without prior
written permission is prohibited, except as allowed under copyright laws.
```

```
HPE3499A Series Emulation System
Version:  A.05.00 19Jan95 17:01 Proto
Location:  Generics
```

```
HPE3491A Pentium (tm)Processor Probe Emulator
Version:  A.01.00 05Jan95 12:22 Proto
```

R>

The version numbers may be different for your HP E3491A Pentium Probe.

3 Press the Return or Enter key a few times.

You should see a prompt such as "R>" or "p>".

See Also "Problems with the Serial Interface," page 46.

To configure LAN parameters using the built-in terminal interface

This procedure should only be used if you have difficulty establishing LAN communication via the HP 16505A Prototype Analyzer Run Control interface.

- 1 Set configuration switches S1 through S4 to CLOSED, and set the other switches as appropriate for your serial interface.**

Switch settings are printed on the bottom of the HP E3491A Pentium Probe. If you will use a baud rate of 9600 baud, set the switches like this:

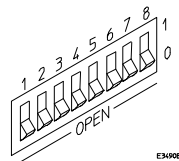

- 2 Connect an ASCII terminal (or terminal emulator) to the HP E3491A Pentium Probe's RS-232 port with a 9-pin RS-232 cable.**

Complete instructions for setting up a serial connection begin on page 15.

- 3 Plug in the HP E3491A Pentium Probe's power cord. Press the terminal's <RETURN> key a couple times. You should see a "p>" or "R>" prompt.**

At this point, you are communicating with the HP E3491A Pentium Probe's built-in terminal interface.

- 4 Display the current LAN configuration values by entering the **lan** command:**

```
R>lan
lan is disabled
lan -i 0.0.0.0
lan -g 0.0.0.0
lan -p 6470
Ethernet Address : 08000903212f
```

The "lan -i" line shows the current IP address (IP address) of the HP E3491A Pentium Probe.

The Ethernet address, also known as the link level address, is preassigned at the factory, and is printed on a label above the LAN connectors.

- 5 Enter the following command:**

```
lan -i <internet> [-g <gateway>] [-p <port>]
```

The lan command parameters are:

- i <internet> The IP address which you obtained from your network administrator.
- g <gateway> The gateway address. Setting the gateway address allows access outside your local network or subnet.
- p <port> This changes the base TCP service port number.

The prototype analyzer uses the TCP service port numbers 6470 and 6471. If these numbers are somehow changed in the Pentium probe, they must be changed back to 6470 and 6471. To change these numbers, you could modify the line:

```
hp64700 6470/tcp
```

6 Disconnect the power cord from the HP E3491A Pentium Probe, and connect the the HP E3491A Pentium Probe to your network.

This connection can be made by using either the 10BASE-T connector or the 10BASE2 (BNC) connector on the HP E3491A Pentium Probe. Do not use both connectors at the same time.

7 Set the configuration switches to indicate the type of connection that is to be made.

Switch S1 must be set to OPEN, indicating that a LAN connection is being made.

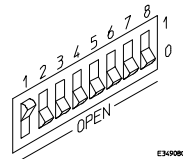

Switch S5 should be 1 if you are connecting to the BNC connector:

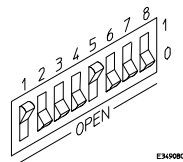

Switch S5 should be 0 if you are connecting to the 10BASE-T connector:

Set all other switches to CLOSED.

8 Connect the power cord to the HP E3491A Pentium Probe.

9 Verify your HP E3491A Pentium Probe is now active and on the network. See "To verify LAN communications" on page 17.

Setting Up a Serial Connection
To configure LAN parameters using the built-in terminal interface

Once you have set a valid IP address, you can use prototype analyzer to verify LAN communication.

Example

For example, to assign an IP address of 192.6.94.2 to the HP E3491A Pentium Probe, enter the following command:

```
R>lan -i 192.6.94.2
```

The IP address and any other LAN parameters you change are stored in nonvolatile memory and will take effect the next time the HP E3491A Pentium Probe is powered off and back on again.

See Also

"Solving Problems," page 39, if you have problems verifying LAN communication.

Connecting to the Target System

Connecting to a Target System

The E3491A Pentium Probe can be connected to a target system by the methods listed below.

- Directly through the Intel defined 20- or 30-pin debug connector.
- Through the HP E2457A Pentium Preprocessor Interface.
- Through a custom designed interface.

This chapter describes the procedures to connect to the Intel defined debug connectors and the E2457A Pentium preprocessor. To design a custom interface refer to chapter 3 "Designing a target system for use with the Intel-defined debug interface."

Connectors provided

The following components are provided with the E3491A Pentium probe for the purpose of testing the probe and connecting to a target system.

- A 20-conductor cable assembly (HP part number E3491-61601)
- A 30-conductor cable assembly (HP part number E3491-61602)
- An adapter board (HP part number E2491-66503)
- A 2-conductor cable assembly with SMT Grabbers (HP part number 64762-61602)
- A self-test connector (HP part number E3490-61604)

To test the HP E3491A Pentium Probe

If this is the first time that you have used the E3491A Pentium Probe, you should run the built-in performance verification test before you connect to a target system. Refer to chapter 5 for information on performance verification.

To connect to a target system via the Intel defined debug port

If the target system has been designed with the Intel defined 20- or 30-pin debug port, the HP E3491A Pentium probe should be connected to the target system using one of the 20- or 30-conductor cable assemblies provided.

- 1** Remove power from the target system and the probe.
- 2** Plug the adapter board in the E3491A Pentium Probe.
- 3** Plug the 30-pin connector end of the 20- or 30-conductor cable assembly into the adapter.
- 4** If you are using the 20-conductor assembly, plug the 20-pin connector end of the cable assembly into the 20-pin debug port in the target system.
- 5** If you are using the 30-conductor assembly, plug the 30-pin connector end of the cable assembly into the 30-pin debug port in the target system.
Note that pins 21 - 30 are not used by the HP E3491A; the probe does not support the dual processor capability of the 30-pin debug port.
- 6** Turn on the power to the probe, then turn on the power to the target system.

To connect to a target system via the HP E2457A Pentium Preprocessor

If the target system does not have either the 20- or 30-pin Intel-defined debug port, the HP E3491A Pentium Probe can be connected to the target system through the HP E2457A Pentium Preprocessor Interface. The 64762-61602 cable assembly is used to connect the DBRESET signal from the HP E3491A Pentium Probe because DBRESET is not a Pentium processor pin. In target systems where it is not known if there are target system resources driving the TCK, TDI, TDO, TMS, TRST, PRDY or R/S# signals, the target system signals can be isolated from the processor by removing the associated pins from one of the pin protectors on the bottom side of the E2457A Pentium Preprocessor.

To connect to the target system:

- 1** Remove power from the target system, logic analyzer and the probe.
- 2** Plug the adapter board in the E3491A Pentium Probe.
- 3** Plug the 30-pin connector end of the 20-conductor cable assembly into the adapter.
- 4** Plug the 20-pin connector end of the 20-conductor cable assembly into the 20-pin debug connector of the HP E2457A Pentium Preprocessor.
- 5** Connect the 2-conductor cable assembly to J3 or J6 of the E2457A Pentium Preprocessor. J3 provides a high system reset to the target system. J6 provides a low true system reset to the target system.
- 6** Connect the free leads from the 2-conductor cable assembly to the target system reset circuitry.
- 7** Power up the software probe, then the logic analyzer, then the target system.

Figure 6

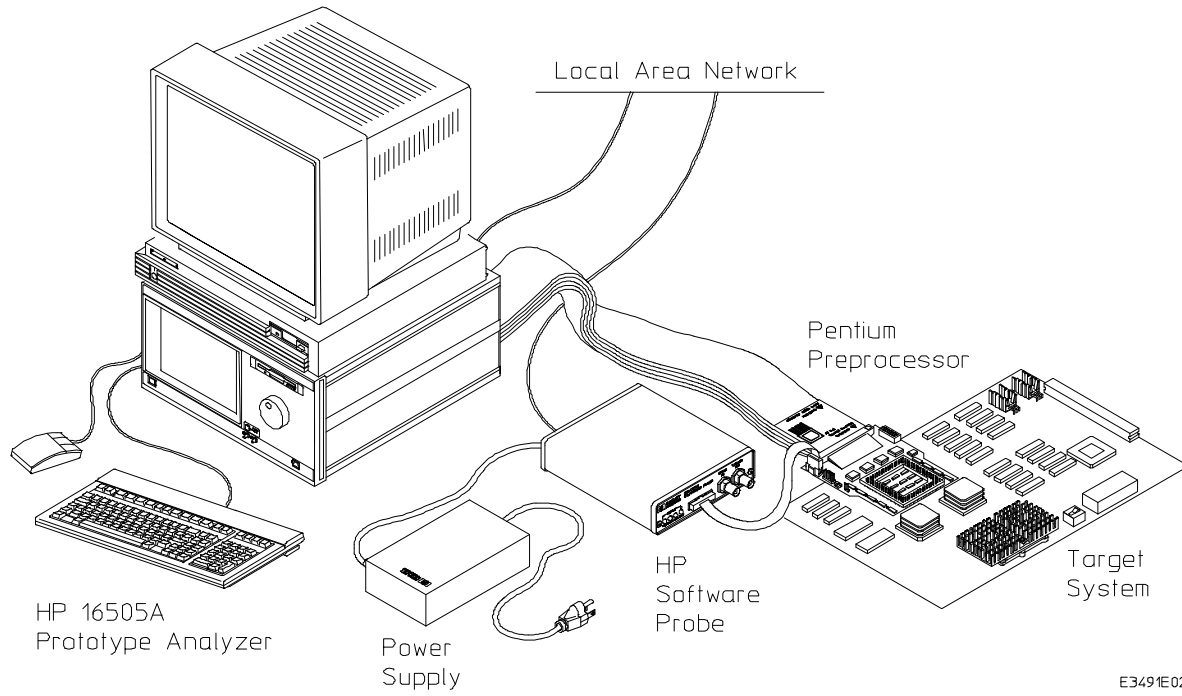

Connecting through the HP E2457A Preprocessor Interface

Reference

Designing a Target System

Designing a Target System

This chapter will help you design a target system that will work with the HP E3491A Pentium Probe.

Designing a target system for use with the HP E2457A Preprocessor Interface

The following should be considered when designing a target system for use with the HP E3491A via the HP E2457A Pentium Preprocessor:

- The TCK, TDI, TMS, TDO, TRST#, R/S# and PRDY target system signals should not require more than 3 ma. at 2.4V or more than 4 ma. at 0.5V. Excessive trace lengths on these signals should be avoided.
- Target system circuitry should not actively drive TCK, TDI, TMS, TRST or R/S#.

If necessary, all of the signals above can be disconnected from the target system by removing the following pins from one of the pin protectors on the bottom of the E2457A Pentium Preprocessor.

TCK (pin M34), TMS (pin P34), TDI (pin N35), TDO (pin N33), TRST# (pin Q33), R/S# (pin AC35), PRDY (pin AC05)

- To enable the E3491A Pentium Probe to reset the target system, an input to the target system reset circuitry must be provided. This can be connected to the target system by the 2-conductor cable assembly (HP part number 64762-61602). A high true reset is available from J3 of the HP E2457A. J3 can source 3 ma at 2.4 v and sink 4 ma at 0.5V. A low true reset is available from J6 of the HP E2457A. J3 can source 3 ma at 2.4V and can sink 64 ma at 0.55V.

Designing a target system for use with the Intel-defined debug port

For information about designing an Intel defined debug port refer to "Pentium Family User's Manual" Volume 1 chapter 31. (Intel order #241428-003).

In addition, the following should be considered when designing a target system for use with the Intel defined debug port.

- The Vcc from the target system should be sourced from the Pentium Vcc not +5 volts.
- The second processor in the 30-pin debug port definition is not currently supported by the HP E3491A.
- Only one device, the Pentium processor, is allowed in the boundary scan path when the HP E3491A is connected.

For a pinout of the debug port, refer to chapter 4, Specifications and Characteristics.

Specifications and Characteristics

Processor Compatibility

The HP E3491A Pentium Probe supports the Pentium microprocessors at iCOMP INDEX 735/90 and 815/100.

Electrical Specifications

BNC, labeled TRIGGER OUT

Output Drive Logic high level with 50-ohm load ≥ 2.0 V. Logic low level with 50-ohm load ≤ 0.4 V. Output function is selectable by the HP 16505A Prototype Analyzer. Refer to Online Help for additional information.

BNC, labeled BREAK IN

Input Edge-triggered TTL level input (active high), 20 pf, with 2K ohms to ground in parallel. Maximum input: 5 V above V_{CC} ; 5 V below ground. Input function is selectable by the HP 16505A Prototype Analyzer. Refer to Online Help for additional information.

Communications

Serial Port 9-pin female type "D" subminiature connector. RS-232 DCE to 115.2 kbaud.

10BASE-T LAN Port RJ-45 connector. IEEE 802.3 10BASE-T (StarLAN).

10BASE 2 LAN Port 50-ohm BNC connector. IEEE 802.3 10BASE2 (ThinLAN). When using this connector, the HP E3491A Pentium Probe provides the functional equivalent of a Medium Attachment Unit (MAU) for ThinLAN.

Power Supply

Input 100-240 V, 9.75 A, 50/60 Hz, IEC 320 connector.

Output 5 V, 1.0 A

Accessory Output 100-240 V, 9.50 A, 50/60 Hz

Maximum Ratings

CharacteristicS for HP E3491A Pentium Probe	Notes	Symbol	Min	Max	Unit
Input voltage range (Vcct only)	1, 2	V _{in}	-0.3	5.5	V
Input voltage range (All others)		V _{in}	-0.5	5.5	V
Input Current (Vcct only)		I _{ii}		15	μA
Input High Voltage (except Vcct)	3	V _{ih}	2.0		V
Input Low Voltage (except Vcct)	3	V _{il}		0.8	V
Input High Current	3	I _{ih}		-15	μA
Input Low Current	3	I _{il}		100	μA
Output High Voltage	4	V _{oh}	2.4	Vcct + 0.5	V
Output Low Voltage	4	V _{ol}		0.5	V
Output High Current	4	I _{oh}	3		mA
Output Low Current	4	I _{ol}	-4		mA

Notes

- 1 Vcct = target system microprocessor voltage
- 2 When connected to a Pentium 735/90 or 815/100 this voltage should not exceed the Vcc of the microprocessor
- 3 INIT, PRDY, RESET, TDO
- 4 TCK, TDI, TMS, TRST#, R/S#, DBRESET

CharacteristicS for HP E2457A Pentium Preprocessor, J3 and J6	Notes	Symbol	Min	Max	Unit
Output High Voltage (J3 only)	5	V _{oh}	2.4	Vcct + 0.5	V
Output Low Voltage (J3 only)	5	V _{ol}		0.5	V
Output High Current (at Voh, J3 only)	5	I _{oh}	3		mA
Output Low Current (at Vol, J3 only)	5	I _{ol}	-4		mA
Output High Voltage (J6 only)	6	V _{oh}	2.4	5.0	V
Output Low Voltage (J6 only)	6	V _{ol}		0.55	V
Output High Current (at Voh, J6 only)	6	I _{oh}	3		mA
Output Low Current (at Vol, J6 only)	6	I _{ol}	-64		mA

Notes

- 5 J3 = DBRESET from the HP E3491A
- 6 J6 = inverted DBRESET from the HP E2457A

Environmental Specifications

Temperature

Operating, 0 to +40 °C (+32 to +104 °F); nonoperating, -40 to +60 °C (-40 to +140 °F).

Altitude

Operating/nonoperating 4600 m (15 000 ft).

Relative Humidity

15% to 95%.

Pinout for 30-pin HP E3491-66503 Adapter Board

Pin Number	E3491-66503 Pin Name	HP E3491 Usage
1	INIT	INIT signal from the target system
2	DBRESET	Reset output from the HP E3491A
3	RESET	RESET signal from the target system
4	GND	
5	not connected	
6	VCC	Vcc from the Pentium microprocessor
7	R/S# 1	R/S# signal from the target system
8	GND	
9	not connected	
10	GND	
11	PRDY 1	PRDY signal from the target system
12	TDI	JTAG signal
13	TDO	JTAG signal
14	TMS	JTAG signal
15	GND	
16	TCK	JTAG signal
17	GND	
18	TRST#	JTAG signal
19	DBINST#	Grounded when the target debug port is connected to the HP E3491A
20	BSEN#	Grounded when the target debug port is connected to the HP E3491A
21	PRDY 2	Not supported by the HP E3491A
22	GND	
23	R/S# 2	Not supported by the HP E3491A
24 - 28	not connected	
29	GND	
30	not connected	

5

Solving Problems

Solving Problems

If you have problems with the HP E3491A Pentium Probe, your first task is to determine the source of the problem. Problems may originate in any of the following places:

- The HP E3491A Pentium Probe itself
- The connection between the HP E3491A Pentium Probe and the target system
- The target system

You can use two means to determine the source of the problem:

- The status lights on the HP E3491A Pentium Probe
- The HP E3491A Pentium Probe "performance verification" tests

Status lights

The following illustration shows the status lights on both sides of the HP E3491A Pentium Probe and what they mean:

Lit when the target processor is running in normal (user program) mode

Lit when the target processor is running in debug mode

Lit when the target system is in a reset state

Lit when the power supply is properly connected to the HP E3491A

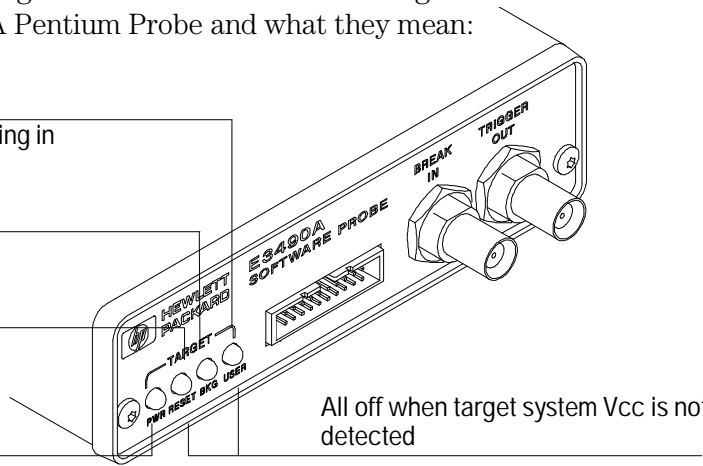

All off when target system Vcc is not detected

E3490E07

Lit when LAN data is being transmitted

Lit when 10BASE-T connection has a good link; not used for 10BASE2

Lit when the polarity on the receive twisted pair is reversed for a 10BASE-T connection

Lit when LAN data is being received

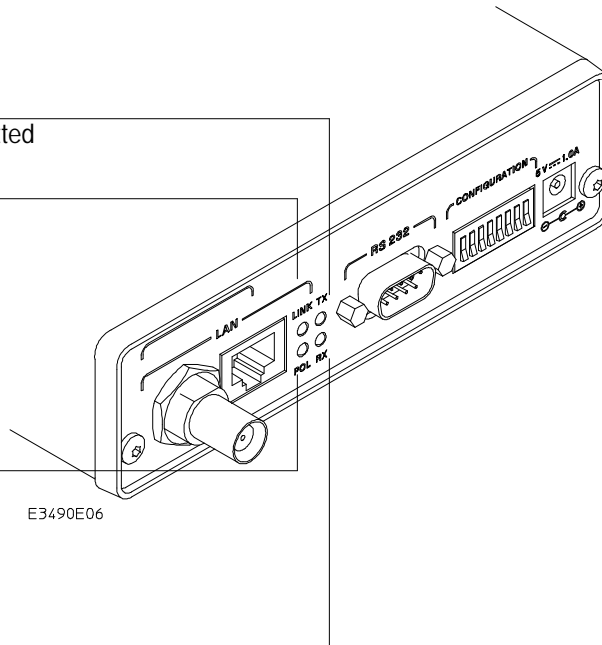

E3490E06

Figure 7. Status Lights

Status Lights

The HP E3491A Pentium Probe communicates various modes and error conditions via the status lights. The meanings of the status lights are shown on the previous page.

The following table gives more information about the meaning of the power and target status lights.

○ = LED is off

● = LED is on

* = Not applicable (LED is off or on)

Power/Target Status Lights

Pwr/Target LEDs	Meaning
○○○○	HP E3491A Pentium Probe is not connected to power supply
●○○○	No target system power, or HP E3491A Pentium Probe is not connected to the target system
●●○○	Target system is in a reset state
●○●●	Only boot firmware is good (other firmware has been corrupted)
●○●○	Target system is executing in Debug Mode
●○○●	Target system is executing user code

Problems with the LAN Interface

If you cannot verify LAN communication

If you cannot verify connection using the procedure in "To verify LAN communication", or if the commands are not accepted by the Pentium probe:

- Make sure that you have connected the HP E3491A Pentium Probe to the proper power source and that the power light is lit.
- Make sure that the LAN cable is connected. Refer to your LAN documentation for testing connectivity.
- Make sure that only one of the LAN ports is connected.
- Make sure the HP E3491A Pentium Probe communication configuration switches are set correctly. Unplug the HP E3491A Pentium Probe power cord, then plug it in again to make sure the switch settings are read correctly by the HP E3491A Pentium Probe.
- Make sure that the HP E3491A Pentium Probe's IP address is set up correctly. Use the RS-232 port to verify this that the IP address is set up correctly. When you are connected to the RS-232 port, run performance verification on the HP E3491A Pentium Probe's LAN interface with the "pv" command.
- It's also possible for there to be a problem with the HP E3491A Pentium Probe firmware while the LAN interface is still up and running. In this case, you must reboot the HP E3491A Pentium Probe by disconnecting power to the HP E3491A Pentium Probe and reconnecting it again.

If you have LAN connection problems

- If the Pentium probe does not accept commands from the prototype analyzer:
 1. Check that switch S1 is "0" (attached to LAN, not RS-232).
 2. Check that switch S5 is in the correct position for your LAN interface (either 10BASE2 or 10BASE-T).(Remember: if you change any switch settings, the changes do not take effect until you cycle power.)

- If the HP E3491A Pentium Probe still does not respond, you need to verify the IP address and gateway mask of the HP E3491A Pentium Probe. To do this, connect the HP E3491A Pentium Probe to a terminal or terminal emulator (see page 15), change the switch settings so it is connected to RS-232, and enter the "lan" command. The output looks something like this:

```
lan -i 15.5.24.116
lan -g 15.5.23.1
lan -p 6470
Ethernet Address : 08000909BAC1
```

"lan -i" shows the internet address is 15.5.24.116 in this case. If the Internet address (IP) is not what you expect, you can change it with the 'lan -i <new IP>' command.

"lan -g" shows the gateway address. Make sure it is the address of your gateway if you are connecting from another subnet, 0.0.0.0 if you are connecting from the local subnet.

"lan -p" shows the port is 6470. If the port is not 6470, you must change it with the "lan -p 6470" command (unless you have deliberately set the port number to a different value because of a conflict).

If the "POL" LED is lit

The "POL" LED indicates that the polarity is reversed on the receive pair if you are using a 10BASE-T connection. The HP E3491A Pentium Probe should still work properly in this situation, but other LAN devices may not work.

If it takes a long time to connect to the network

- Check the subnet masks on the other LAN devices connected to your network. All of the devices should be configured to use the same subnet mask.

Subnet mask error messages do not indicate a major problem. You can continue using the HP E3491A Pentium Probe.

The HP E3491A Pentium Probe automatically sets its subnet mask based on the first subnet mask it detects on the network. If it then detects other subnet masks, it will generate error messages.

If there are many subnet masks in use on the local subnet, the HP E3491A Pentium Probe may take a very long time to connect to the network after it is turned on.

To "clean up" the network, connect a terminal to the HP E3491A Pentium Probe. You can then see error messages which will help you identify which devices on the network are using the wrong subnet masks.

Problems with the Serial Interface

If you cannot verify RS-232 communication

If the HP E3491A Pentium Probe prompt does not appear in the terminal emulator window:

- Make sure that you have connected the HP E3491A Pentium Probe to the proper power source and that the power light is lit.
- Make sure that you have properly configured the data communications switches on the HP E3491A Pentium Probe and the data communications parameters on the host computer. You should also verify that you are using the correct cable.

The most common type of data communications configuration problem involves the configuration of the HP E3491A Pentium Probe as a DTE device instead of as a DCE device. If you are using the wrong type of cable, no prompt will be displayed.

A cable with one-to-one connections will work with a PC or an HP Series 700 workstation.

If you have RS-232 connection problems with the MS Windows Terminal program

- Remember that Windows 3.1 only allows two active RS-232 connections at a time. To be warned when you violate this restriction, choose Always Warn in the Device Contention group box under 386 Enhanced in the Control Panel.
 - Use the "Terminal" program (usually found in the Accessories windows program group) and set up the "Communications..." settings as follows:
-

If you have RS-232 connection problems with the MS Windows Terminal program

Baud Rate: 19200 (or whatever you have chosen for the emulator)
Data Bits: 8
Parity: None
Flow Control: hardware
Stop Bits: 1

When you are connected, hit the Enter key. You should get a prompt back. If nothing echos back, check the switch settings on the HP E3491A Pentium Probe.

- If the switches are in the correct position and you still do not get a prompt when you hit return, try turning OFF the power to the HP E3491A Pentium Probe and turning it ON again.
- If you still don't get a prompt, make sure the RS-232 cable is connected to the correct port on your PC, and that the cable is appropriate for connecting the PC to a DCE device.

With certain RS-232 cards, connecting to an RS-232 port where the HP E3491A Pentium Probe is turned OFF (or is not connected) will hang the PC. The only way to get control back is to reboot the PC. Therefore, we recommend that you always turn ON the HP E3491A Pentium Probe before attempting to connect via RS-232.

Problems with the HP E3491A Pentium Probe Itself

To run the power up self test

- 1 Unplug the HP E3491A Pentium Probe, then plug it in.
- 2 Watch the status lights. They should show the following pattern:
 - = LED is off
 - = LED is on
 - * = Not applicable (LED is off or on)

Normal sequence during power up self test

	Pwr/Target LEDs	Meaning
1	●●●●	Initial power up, system reset
2	●○○○	XILINX array initialized successfully
3	●○○●	XILINX array tested successfully
4	●○○○	BOOT ROM space tested successfully
5	●○○●	GENERIC ROM space tested successfully
6	●○○○	DRIVER ROM space tested successfully
7	●○○●	RESERVED ROM space tested successfully
8	●○○○	RAM tested successfully
9	●○○●	LAN internal feedback tested successfully
10	●○○●	Start system, load drivers, initialize LAN

If the power up self test fails, the RESET LED will flash the number of the test, then stay lit.

If any of the LEDs fail to change, or all of them remain on, there is a system failure.

Following power up, the LEDs will enter one of the following states:

- No target system power, or HP E3491A Pentium Probe is not connected to the target system, or
- Target system is in a reset state
- Only the boot ROM was used; other firmware in the Flash EPROM has been corrupted

Starting a user interface will change the pattern to the one requested by the interface.

If the power up self tests fail, try the following:

- Check and reset the LAN address as shown in the "Connecting to the HP 16505A Prototype Analyzer" chapter. LAN powerup failures will occur if the HP E3491A Pentium Probe does not have a valid Link Level Address and IP Address.
- Disconnect all external connections, including the LAN, serial (RS-232), and BNC Break and Trigger cables, then cycle power.
- To ensure that the firmware is working as it should, reprogram the firmware, then cycle power.

To execute the built-in performance verification test

In addition to the powerup tests, there are six additional performance verification tests available. These six tests are Powerup PV Results, LAN 10BASE2 Feedback Test, LAN 10BASET Feedback Test, Break In and Trigger Out BNC Feedback Test, Target Probe Feedback Test, and Boundary Scan Master Test.

Four of these tests can be invoked through the prototype analyzer. The LAN tests can only be executed through the RS-232 port.

To perform the PV tests through the prototype analyzer:

- 1 Disconnect the target cable from the target system, and attach the terminator to the end of the target system cable.**
- 2 In the Sys Admin menu, select Start PV.**

The results will appear on screen.

LAN Tests

The LAN tests can only be executed through the RS-232 port. The remainder of this section assumes that the tests are being run from a terminal emulator connected to the RS-232 port.

For the BREAK IN, TRIGGER OUT BNC FEEDBACK TEST, connect a coaxial cable between BREAK IN and TRIGGER OUT

For the TARGET PROBE FEEDBACK TEST, replace target cable with feedback connector E3490-61604

- 1 Set all of the switches to OPEN.**

This is standard RS-232 at 9600 baud which can be connected directly to a 9 pin RS-232 interface that conforms to the IBM PC-AT 9 pin standard.

- 2 Use a terminal emulator to connect to the HP E3491A Pentium Probe.**
- 3 Enter the `pv` command.**

Options available for the "pv" are explained in the help screen displayed by typing "help pv" or "? pv" at the prompt. The help screen output will appear similar to the screen shown on the following page:

R>? pv

pv - Execute the system performance verification diagnostics.

USAGE: pv <-l> <-t*|x[-y]> <-f> <-vverbose_level> <repeat_count>
pv - display pv warning message
pv <-l> - list pv test#s and descriptions only (do not execute)
pv <-t*|x[-y]> - select pv test number x or tests x thru y only
* selects all emulation tests
pv <-f> - for factory use only
pv <-vverbose> - set verbose level; valid levels: 1-9.
pv <repeat_count> - execute diagnostics (repeat_count) number of times.
repeat_count of 0 repeats until keyboard break

SETUP:

10BASE2 FEEDBACK TEST:

Disconnect 10Base2 Connector From the Network
Terminate With Two 50 Ohm Terminators on a TEE

10BASET FEEDBACK TEST:

Connect 10BaseT Connector To Active Port

Examples:

To execute both tests one time:

pv 1

To execute test 2 with maximum debug output repeatedly until a ^C is entered:

pv -t2 -v9 0

To execute tests 3, 4, and 5 only for 2 cycles:

pv -t3-5 2

Solving Problems
To execute the built-in performance verification test

The tests available through this command can be displayed as follows:

```
R>pv -1
Tests Available in Performance Verification;
Test # 1: Powerup PV Results
Test # 2: LAN 10Base2 Feedback Test
Test # 3: LAN 10BaseT Feedback Test
Test # 4: Break In and Trigger Out BNC Feedback Test
Test # 5: Target Probe Feedback Test
Test # 6: Boundary Scan Master Test
```

R>

On a good system, when the E3490-61604 feedback connector is plugged into the 20 pin target connector, the RESET LED will light and the BKG and USER LEDs will be out.

The results on a good system are as follows:

```
R>pv 1

Testing: HPE3499A Series Emulation System
Test # 1: Powerup PV Results           passed!
Test # 2: LAN 10Base2 Feedback Test    passed!
Test # 3: LAN 10BaseT Feedback Test    passed!
Test # 4: Break In and Trigger Out BNC Feedback Test  passed!
Test # 5: Target Probe Feedback Test   passed!
Test # 6: Boundary Scan Master Test    passed!
PASSED Number of tests: 1             Number of failures: 0
```

Copyright (c) Hewlett-Packard Co. 1987
All Rights Reserved. Reproduction, adaptation, or translation without prior written permission is prohibited, except as allowed under copyright laws.

```
HPE3499A Series Emulation System
Version:  A.05.00 19Jan95 15:53 Proto
Location:  Generics

HPE3491A Pentium(tm) Processor Probe Emulator
Version:  A.01.00 05Jan95 13:07 Proto
```

R>

There are some things you can do if a failure is found on one of these tests. Details of Failure can be obtained through using a verbose level of 2 or more.

TEST 2: LAN 10BASE2 Feedback Test

For LAN 10BASE2 test, the following is an example of a failure which is *not* caused by a broken HP E3491A Pentium Probe.

```
R>pv -t2 -v2 1
```

```
Testing: HPE3499A Series Emulation System
Test # 2: LAN 10Base2 Feedback Test                failed!
  FAILED - no lan connection (LAN probably not terminated)
FAILED Number of tests: 1          Number of failures: 1
```

Check to see that the port under test has a good cable connected to it and that the cable is properly terminated with a 50 ohm terminator on each end of the overall cable.

```
R>pv -t2 -v2 1
```

```
Testing: HPE3499A Series Emulation System
Test # 2: LAN 10Base2 Feedback Test                failed!
  FAILED due to excessive collisions
FAILED Number of tests: 1          Number of failures: 1
```

The most common cause of this problem is poor termination of the cable or failure to remove the port under test from the LAN before performing the test. Check to see that the terminators are good (50 Ohms) and that you are isolated from any traffic on a system LAN.

```
R>pv -t2 -v2 1
```

```
Testing: HPE3499A Series Emulation System
Test # 2: LAN 10Base2 Feedback Test                failed!
  FAILED - invalid Ethernet address in EEPROM
FAILED Number of tests: 1          Number of failures: 1
```

First check to see that a correct LLA and IP address have been set in the virtual EEPROM through the "lan" command. If the "lan" command shows bad information for the LLA and IP, then try to set them to correct values. If you are unable to set them to correct values, there is a failure in the FLASH ROM which requires service from HP.

Test 3: 10BaseT Feedback Test

```
R>pv -t3 -v2 1
```

```
Testing: HPE3499A Series Emulation System
  Test # 3: LAN 10BaseT Feedback Test           passed!
PASSED  Number of tests: 1           Number of failures: 0
```

In addition to the internal checks performed in Test 2, this test also checks for shorts on the cable connected to the network. If this test fails, disconnect the cable and run the test again. If it then passes, the cable is faulty. If it still fails, it requires service from HP.

If the HP E3491A Pentium Probe passes this "pv" test, additional testing can be performed through exercising the connection to the network. To run this test, set configuration switch 1 and switch 5 to OPEN, all other configuration switches CLOSED (this enables LAN using 10BaseT). Cycle power and wait for 15 to 30 seconds. Then "ping" the HP E3491A Pentium Probe from your host computer or PC. See the LAN documentation for your host computer for the location and action of the "ping" utility. If the HP E3491A Pentium Probe fails to respond to the "ping" request, verify that the lan parameters (IP address and gateway address) are set correctly and that your host computer recognizes the IP address of the HP E3491A Pentium Probe. If all else is good, then failure to respond to ping indicates a faulty HP E3491A Pentium Probe.

TEST 4: Break In and Trigger Out BNC Feedback Test

```
R>pv -t4 -v2 1
```

```
Testing: HPE3499A Series Emulation System
  Test # 4: Break In and Trigger Out BNC Feedback Test   failed!
  Break In not receiving Break Out HIGH
FAILED  Number of tests: 1           Number of failures: 1
```

Before returning to HP, check to ensure that you have connected a good Coaxial cable between the two BNCs. If the cable is good, the E3491A is bad.

TEST 5: Target Probe Feedback Test

A verbose output on this test can be extensive. For example, the following is the output of this test if you forget to plug in the E3490-61604 connector.

```
p>pv -t5 -v2 1
```

```
Testing: HPE3499A Series Emulation System
Test # 5: Target Probe Feedback Test                                     failed!
Bad 20 Pin Status Read when unconnected = 0x7fb7
Expected Value = 0xffb7
Bad 20 Pin Status Read when connected= 7fb7
Expected Value = 0x7fb7
Output 19 Low not received on Input 11
Output 11 Low not received on Input 19
Output 13 Low not received on Input 1
Output 12 High not received on Input 6
Output 12 and Input 6 not pulled high on release
Output 8 Low not received on Input 10
Output 7 Low not received on Input 20
Output 4 Low not received on Input 14
Output 2 Low not received on Input 18
FAILED Number of tests: 1          Number of failures: 1
```

If the you get a verbose output like this, check to make sure that the self test loopback connector was connected properly.

Returning the HP E3491A Pentium Probe to Hewlett-Packard for Service

To return the HP E3491A Pentium Probe to Hewlett-Packard

- 1** Follow the procedures in this chapter to make sure that the problem is caused by a failure in the HP E3491A Pentium Probe or power supply, not by configuration or communication problems.
- 2** Call your nearest HP sales office. Ask them for the address of the nearest HP service center.

A list of HP sales offices is included at the back of this binder.

- 3** Package the HP E3491A Pentium Probe or the power supply and send it to the HP service center.

If only the HP E3491A Pentium Probe is broken, keep the power supply and cables. If only the power supply is broken, keep the HP E3491A Pentium Probe and cables.

- 4** When the HP E3491A Pentium Probe or the power supply has been replaced, it will be sent back to you.

The unit returned to you will have the same serial number as the unit you sent to HP.

To obtain replacement cables

- Order one of the following parts from your HP sales office:

Cable part numbers

Exchange Assemblies

Part Number	Description
E3491-69401	Program Assembly

Replacement Assemblies

Part number	Description
0950-2372	Power Supply
5090-4356	Grabber kit (Pkg of 20)
E3491-61601	20-conductor cable assembly
E3491-61602	30-conductor cable assembly
E3490-61604	self-test connector
64762-61602	2-conductor cable assembly with SMT Grabbers
E3491-66503	adapter board
5061-7342	7 ft. 10Base-T point-to-point network cable assembly

DECLARATION OF CONFORMITY

according to ISO/IEC Guide 22 and EN 45014

Manufacturer's Name: Hewlett-Packard Company
Manufacturer's Address: Colorado Springs Division
1900 Garden of the Gods Road
Colorado Springs, CO 80907 U.S.A.

declares, that the product

Product Name: Software Probe
Model Number(s): HP E3491A
Product Option(s): All

conforms to the following Product Specifications:

Safety: IEC 1010-1: 1990; AMD 1: 1992
UL 3111

EMC:	CISPR 11:1990 / EN 55011:1991	Group 1 Class A
	IEC 801-2:1991 / EN 50082-1:1992	4 kV CD, 8 kV AD
	IEC 801-3:1984 / EN 50082-1:1992	3 V/m, {1kHz 80% AM, 27-1000 MHz}
	IEC 801-4:1988 / EN 50082-1:1992	0.5 kV Sig. Lines, 1 kV Power Lines

Supplementary Information:

The product herewith complies with the requirements of the Low Voltage Directive 73/23/EEC and the EMC Directive 89/336/EEC.

Colorado Springs, 11/10/94

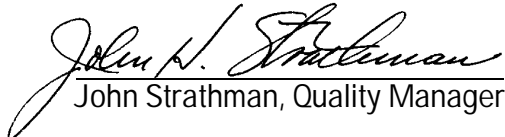
John Strathman, Quality Manager

European Contact: Your local Hewlett-Packard Sales and Service Office or Hewlett-Packard GmbH, Department ZQ / Standards Europe, Herrenberger Strasse 130, D-71034 Böblingen Germany (FAX: +49-7031-14-3143)

Product Regulations

Safety IEC 1010-1: 1990; AMD: 1992
UL 3111

EMC This product meets the requirement of the European Communities (EC)
EMC Directive 89/336/EEC.

Emissions EN55011/CISPR 11 (ISM, Group 1, Class A equipment)
SABS RAA Act No. 24 (1990)

Immunity		Code ¹	Notes ²
	EN50082-1		
	IEC 801-2 (ESD) 4kV CD, 8kV AD	1	
	IEC 801-3 (Rad.) 3 V/m	1	
	IEC 801-4 (EFT) 1kV	1	

¹ Performance Codes:
1 PASS - Normal operation, no effect.
2 PASS - Temporary degradation, self recoverable.
3 PASS - Temporary degradation, operator intervention required.
4 FAIL - Not recoverable, component damage.

² Notes:
(None)

© Copyright Hewlett-Packard Company 1994, 1995
All Rights Reserved.

Reproduction, adaptation, or translation without prior written permission is prohibited, except as allowed under the copyright laws.

Restricted Rights Legend

Use, duplication, or disclosure by the U.S. Government is subject to restrictions set forth in subparagraph (C) (1) (ii) of the Rights in Technical Data and Computer Software Clause in DFARS

252.227-7013.

Hewlett-Packard Company,
3000 Hanover Street, Palo Alto, CA 94304 U.S.A.

Rights for non-DOD U.S. Government Departments and Agencies are set forth in FAR 52.227-19(c)(1,2).

Document Warranty

The information contained in this document is subject to change without notice.

Hewlett-Packard makes no warranty of any kind with regard to this material, including, but not limited to, the implied warranties of merchantability or fitness for a particular purpose.

Hewlett-Packard shall not be liable for errors contained herein or for damages in connection with the furnishing, performance, or use of this material.

Safety

This apparatus has been designed and tested in accordance with IEC Publication 348, Safety Requirements for Measuring Apparatus, and has been supplied in a safe condition. This is a Safety Class I instrument (provided with terminal for protective earthing). Before applying power, verify that the correct safety precautions are taken (see the following warnings). In addition, note the external markings on the instrument that are described under "Safety Symbols."

Warning

- Before turning on the instrument, you must connect the protective earth terminal of the instrument to the protective conductor of the (mains) power cord. The mains plug shall only be inserted in a socket outlet provided with a protective earth contact. You must not negate the protective action by using an extension cord (power cable) without a protective conductor (grounding). Grounding one conductor of a two-conductor outlet is not sufficient protection.
- Only fuses with the required rated current, voltage, and specified type (normal blow, time delay, etc.) should be used. Do not use repaired fuses or short-circuited fuseholders. To do so could cause a shock of fire hazard.

- Service instructions are for trained service personnel. To avoid dangerous electric shock, do not perform any service unless qualified to do so. Do not attempt internal service or adjustment unless another person, capable of rendering first aid and resuscitation, is present.

- If you energize this instrument by an auto transformer (for voltage reduction), make sure the common terminal is connected to the earth terminal of the power source.

- Whenever it is likely that the ground protection is impaired, you must make the instrument inoperative and secure it against any unintended operation.

- Do not operate the instrument in the presence of flammable gasses or fumes. Operation of any electrical instrument in such an environment constitutes a definite safety hazard.

- Do not install substitute parts or perform any unauthorized modification to the instrument.

- Capacitors inside the instrument may retain a charge even if the instrument is disconnected from its source of supply.

Safety Symbols



Instruction manual symbol: the product is marked with this symbol when it is necessary for you to refer to the instruction manual in order to protect against damage to the product.



Hazardous voltage symbol.



Earth terminal symbol: Used to indicate a circuit common connected to grounded chassis.

WARNING

The Warning sign denotes a hazard. It calls attention to a procedure, practice, or the like, which, if not correctly performed or adhered to, could result in personal injury. Do not proceed beyond a Warning sign until the indicated conditions are fully understood and met.

CAUTION

The Caution sign denotes a hazard. It calls attention to an operating procedure, practice, or the like, which, if not correctly performed or adhered to, could result in damage to or destruction of part or all of the product. Do not proceed beyond a Caution symbol until the indicated conditions are fully understood or met.

Product Warranty

This Hewlett-Packard product has a warranty against defects in material and workmanship for a period of one year from date of shipment. During the warranty period, Hewlett-Packard Company will, at its option, either repair or replace products that prove to be defective.

For warranty service or repair, this product must be returned to a service facility designated by Hewlett-Packard.

For products returned to Hewlett-Packard for warranty service, the Buyer shall prepay shipping charges to Hewlett-Packard and Hewlett-Packard shall pay shipping charges to return the product to the Buyer. However, the Buyer shall pay all shipping charges, duties, and taxes for products returned to Hewlett-Packard from another country.

Hewlett-Packard warrants that its software and firmware designated by Hewlett-Packard for use with an instrument will execute its programming instructions when properly installed on that instrument.

Hewlett-Packard does not warrant that the operation of the instrument software, or firmware will be uninterrupted or error free.

Limitation of Warranty

The foregoing warranty shall not apply to defects resulting from improper or inadequate maintenance by the Buyer, Buyer-supplied software or interfacing, unauthorized modification or misuse, operation outside of the environmental specifications for the product, or improper site preparation or maintenance.

No other warranty is expressed or implied. Hewlett-Packard specifically disclaims the implied warranties of merchantability or fitness for a particular purpose.

Exclusive Remedies

The remedies provided herein are the buyer's sole and exclusive remedies.

Hewlett-Packard shall not be liable for any direct, indirect, special, incidental, or consequential damages, whether based on contract, tort, or any other legal theory.

Assistance

Product maintenance agreements and other customer assistance agreements are available for Hewlett-Packard products.

For any assistance, contact your nearest Hewlett-Packard Sales Office.

Certification

Hewlett-Packard Company certifies that this product met its published specifications at the time of shipment from the factory. Hewlett-Packard further certifies that its calibration measurements are traceable to the United States National Institute of Standards and Technology, to the extent allowed by the Institute's calibration facility, and to the calibration facilities of other International Standards Organization members.

About this edition

This is the second edition of the *HP Pentium Probe Installation and Service Guide*.

Publication number
E3491-97001

Printed in USA.

Edition dates are as follows:

First edition, May 1995

Second edition, August 1995

New editions are complete revisions of the manual. Many product updates do not require manual changes, and manual corrections may be done without accompanying product changes. Therefore, do not expect a one-to-one correspondence between product updates and manual updates.

UNIX is a registered trademark in the United States and other countries, licensed exclusively through X/Open Company Limited.